

STORES

100% Materiaux



MEZZO *Symphony collection*

Fashion changes over time



250 - 350 cm

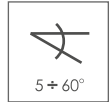
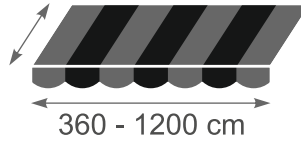

LED light (extra charge)

Standard construction colours:



Real colours can be slightly different than colours above.

ADAGIO *Symphonia collection*

Semi-cassette

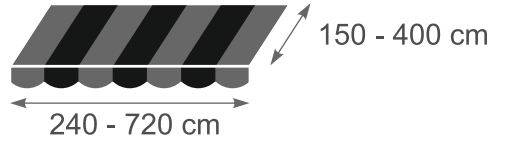

LED light (extra charge)

Standard construction colours:



Real colours can be slightly different than colours above.

VIVO *SYMPHONY collection*

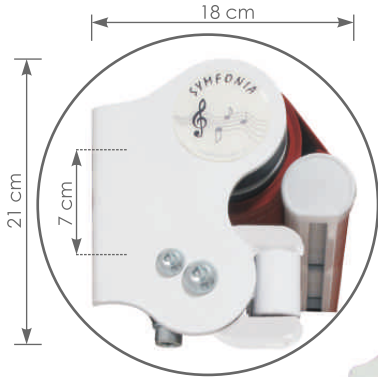

Wall installation

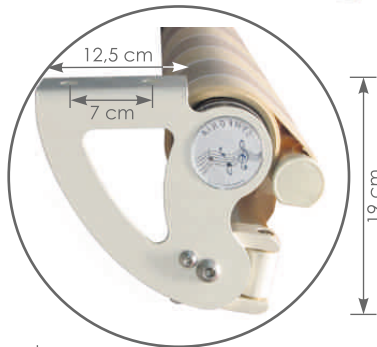
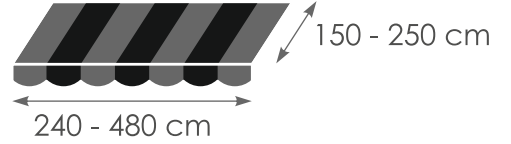
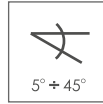

Ceiling installation



Angle adjustment

1. Loosen screws 1 & 2
2. Turn screw no 3 & adjust the angle
3. Tighten screws 1 i 2

Standard construction colours:



RAL
1013

Oyster
white



RAL
9016

Traffic
white



RAL
8017

Chocolate
brown

Real colours can be slightly different than colo

PIANO *Symphonia collection*

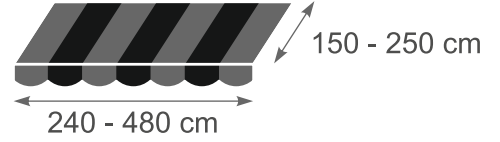
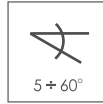

Arm joint

Standard construction colours:



Real colours can be slightly different than colours above.

FORTE *SYMPHONIA collection*

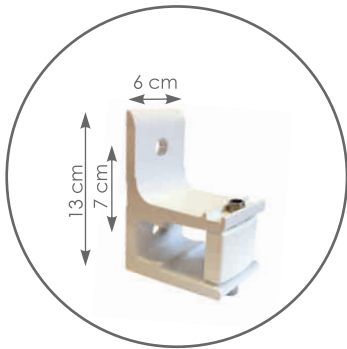
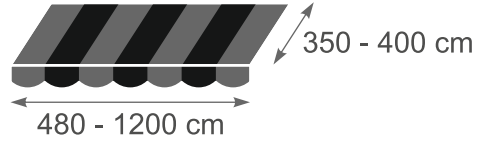
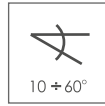
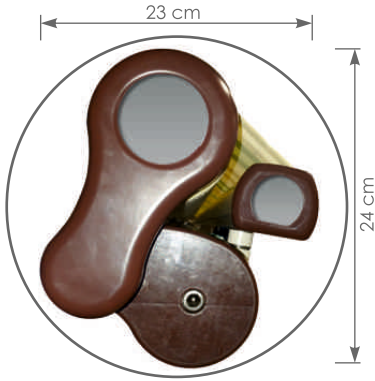

Arm joint

Standard construction colours:



RAL
1013

Oyster
white



RAL
9016

Traffic
white



RAL
8017

Chocolate
brown

Real colours can be slightly different than colours above

BIG

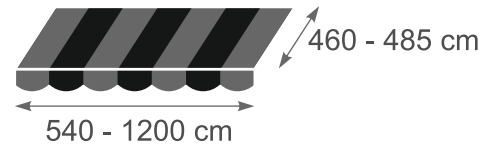
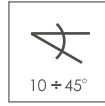

Arm's holder

Standard construction colour:



RAL
1013

Oyster
white

Real colours can be slightly different than colours above.

PRESTO *SYMPHONIA collection*

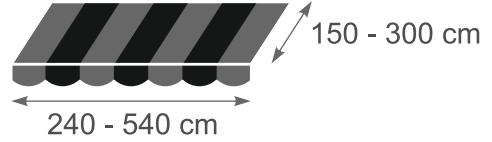

25 cm
Ceiling installation



Wall installation

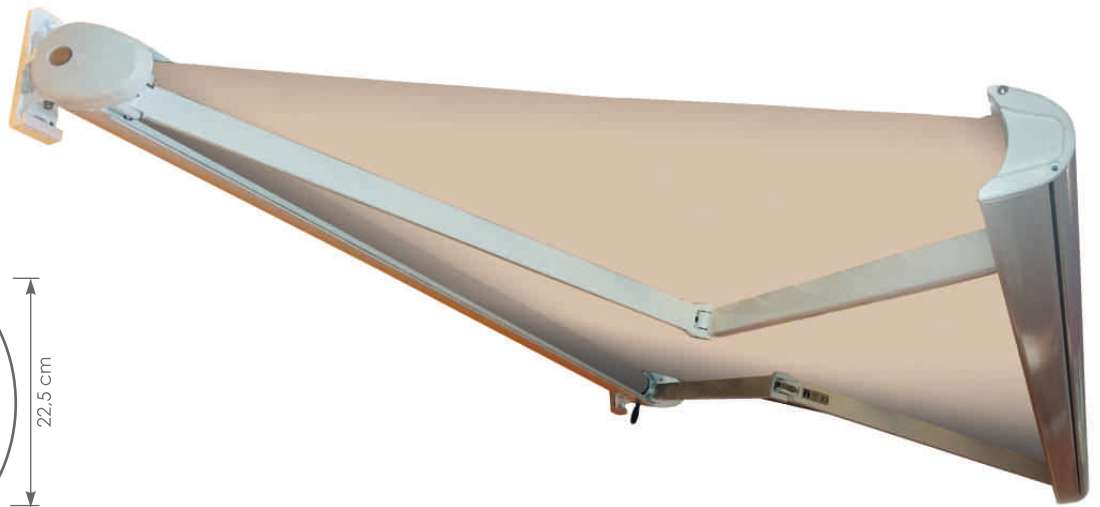

Distance between brackets axes, is 10 cm smaller than the total width of Presto.



Arm joint

Standars construction colours:



Real colours can be slightly different than colours above.

NOWA

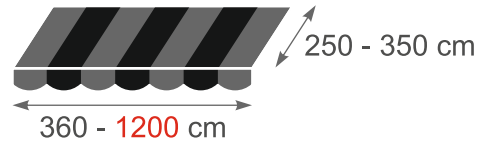

Standard construction colour:



Traffic
white

Real colours can be slightly different than colours above.

CROSS *Symphonia collection*

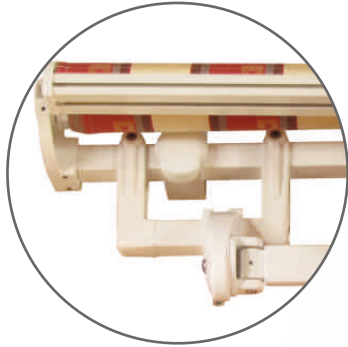

System „CROSS“

35 cm



200 - 350 cm

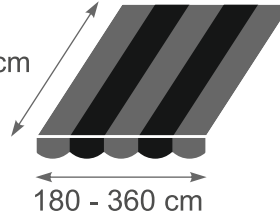

180 - 360 cm



EN 13561

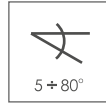

5 + 80°



Arm joint



ADAGIO cassette (option)

Standard construction colours:



Real colours can be slightly different than colours above.

ALLEGRO *Symphonia collectia*

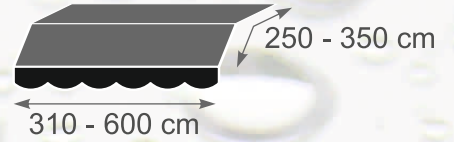
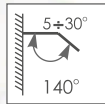
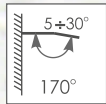
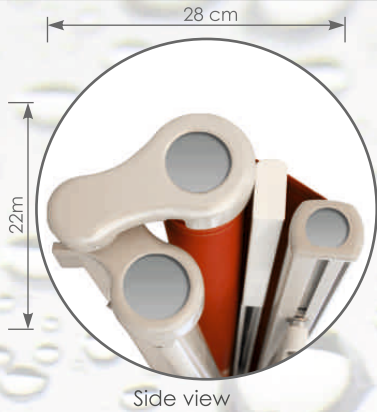

Advertising medium



Standard awning vs Allegro



Standard construction colours:



Oyster white



White aluminum



Anthracite

Real colours can be slightly different than colours above.

COMO&CAPRI

Arms opening up to 90°
Optimal angle of inclination 45°

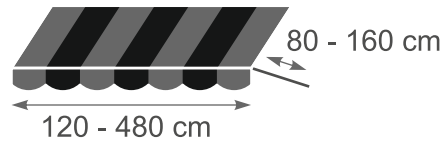

CAPRI



OVAL[®]
SOLUTION

New bracket.
Reduces costs, increases stability.
Installation cheaper by 50 %

CAPRI - motor without NHK (SOMFY)

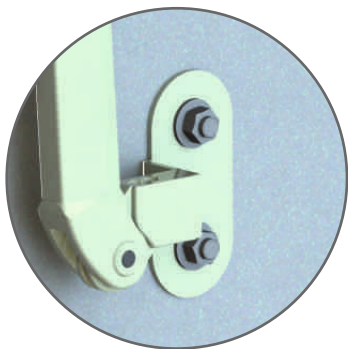

Side bracket (inside the recess)

Standard construction colours:

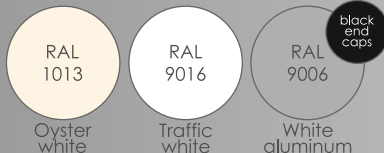

Real colours can be slightly different than colours above.

VERTICA & GARDA

VERTICA
vertical awning



GARDA
balustrade awning

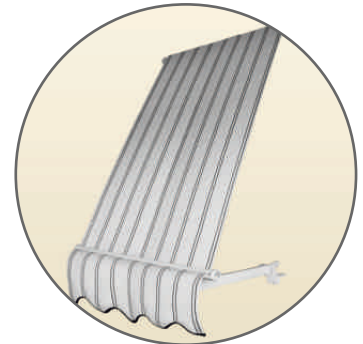
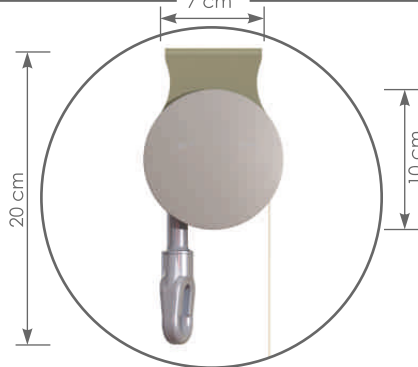

COMO, GARDA, VERTICA

Typical use (GARDA)

We don't join acrylic fabric with PVC



Standard construction colours:

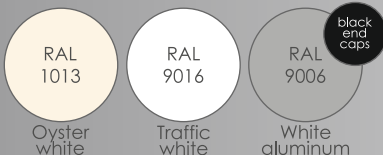

Real colours can be slightly different than colours above.

GIULIANO

an awning... & a roller blind

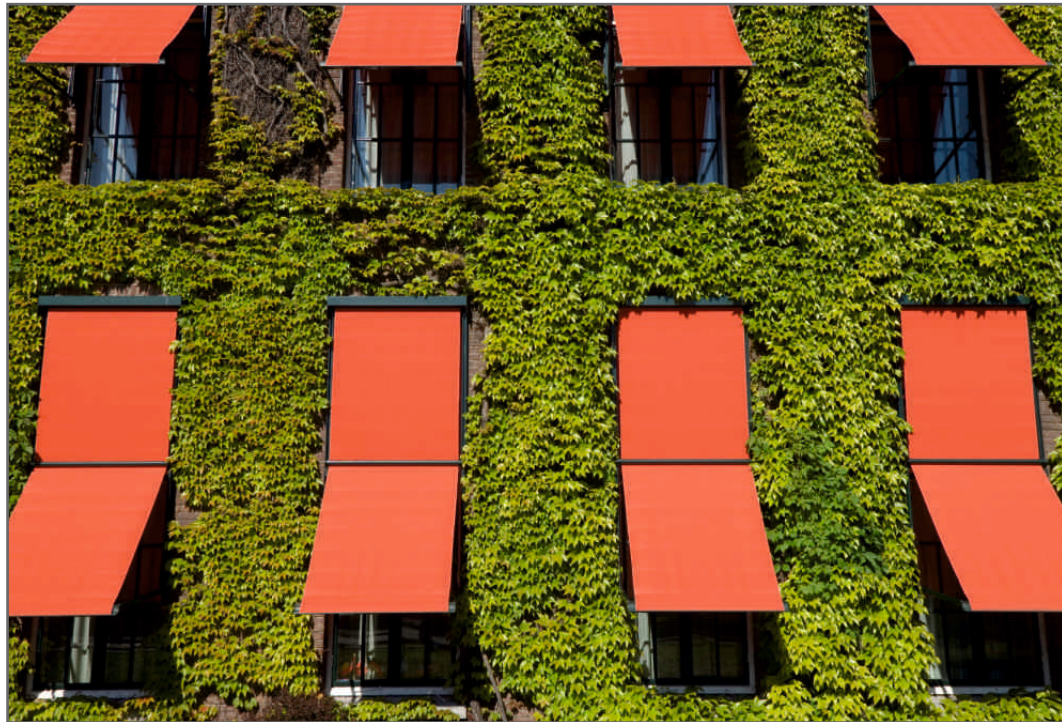
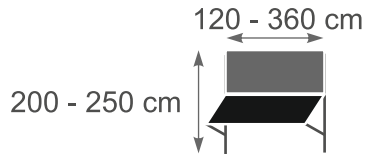

Standard construction colour:

RAL
1013

Oyster
white

Real colours can be slightly different than colours above.

CANOPY

classic, retractable, rounded

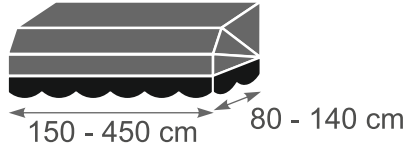

Gear box

Standard construction colour:



RAL
1013

Oyster
white

Real colours can be slightly different than colours above.

TRATTORIA

Pergola



Joining gutter (option)

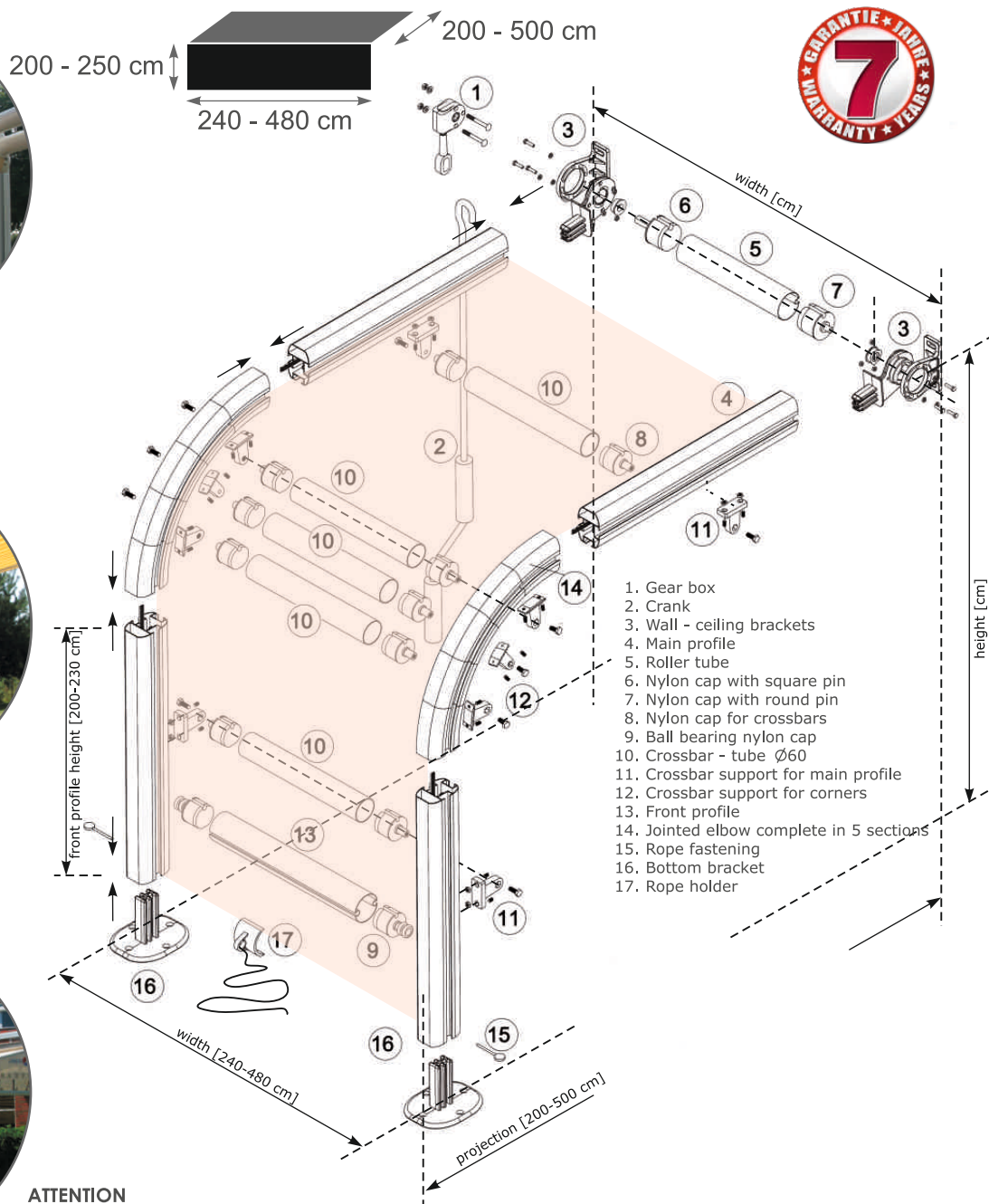

ATTENTION

When placing an order:

- Please give the height on the wall (example below)

EXAMPLES (recommended angle 20°)

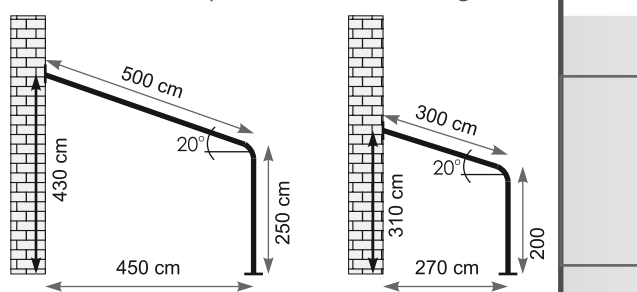

Standard construction colour:

RAL 9010

Pure white

Real colours can be slightly different than colour above.

OMBRA

Pergola

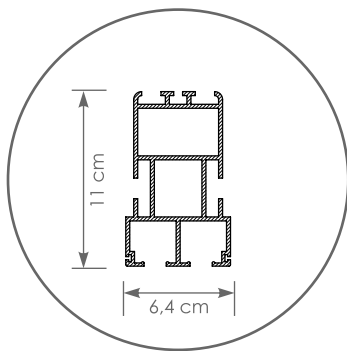

Guides

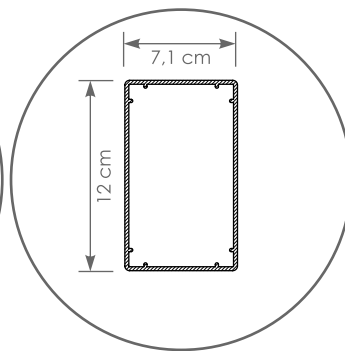

Foot profile

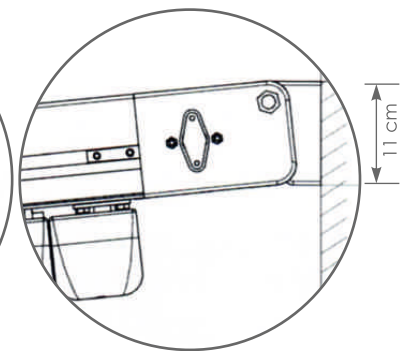
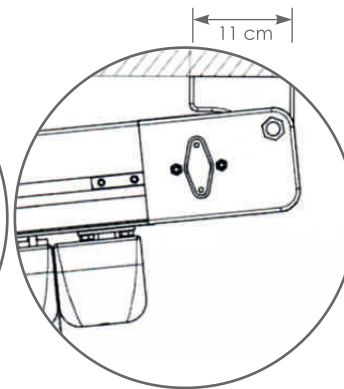

Tolerance in overall width is ± 2 cm

Standard construction colours:



Pure white



Oyster white



Anthracite

Real colours can be slightly different than colours above.

HOOD

to self assemble

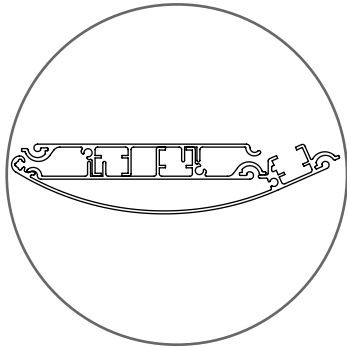

Hood before assembling

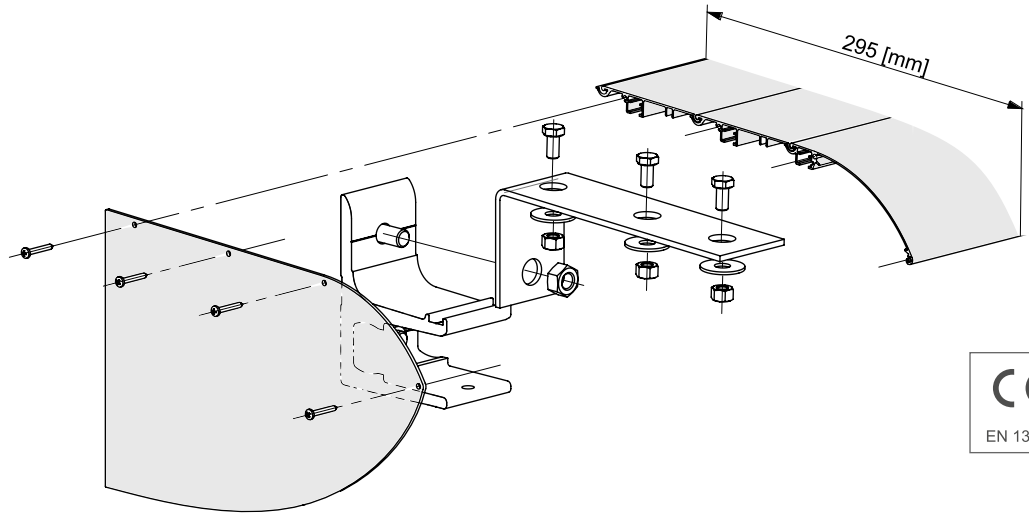

Standard construction colours:



Real colours can be slightly different than colours above.

FRONT BAR SUPPORT

For wind protection



Front bar holder

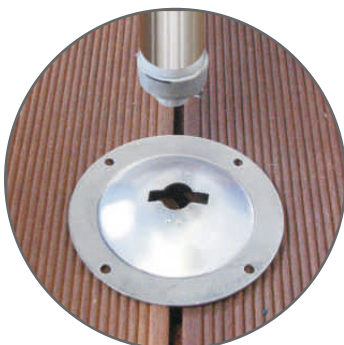

Ground holder

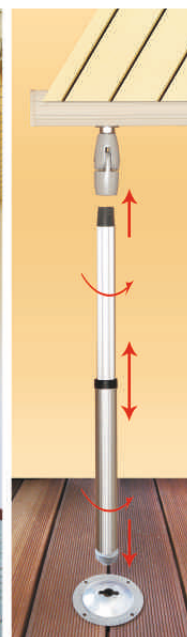

- Easy assemble and disassemble
- Adjustable height from 150 up to 250 cm
- Allows to use the awning in windy days
- Not recommended for awnings with motors
- Not to be used for awnings with wind sensor

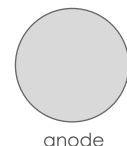

anode

AMARETTO

Lateral cover

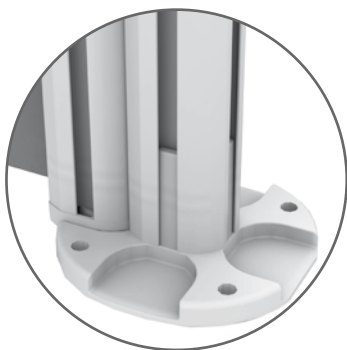
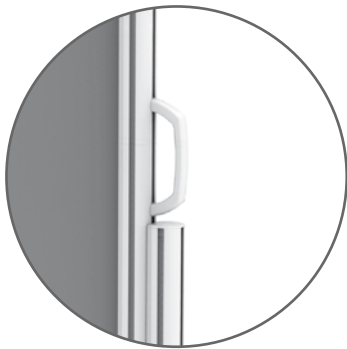
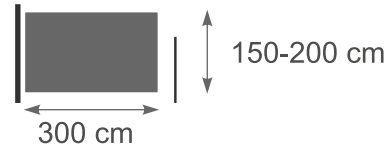
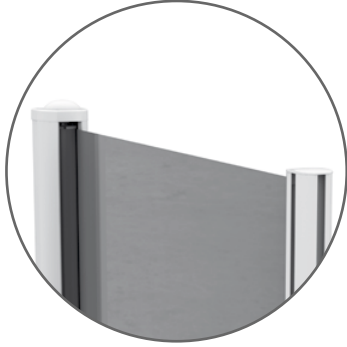

Tolerance in overall width is ± 2 cm

Standard construction colours:



Traffic white



White aluminum

Real colours can be slightly different than colours above.

In standard:

- Handle + pole
- Fabric: brown / silver collection

VERANDA

Works in every plane

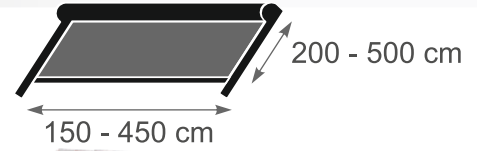
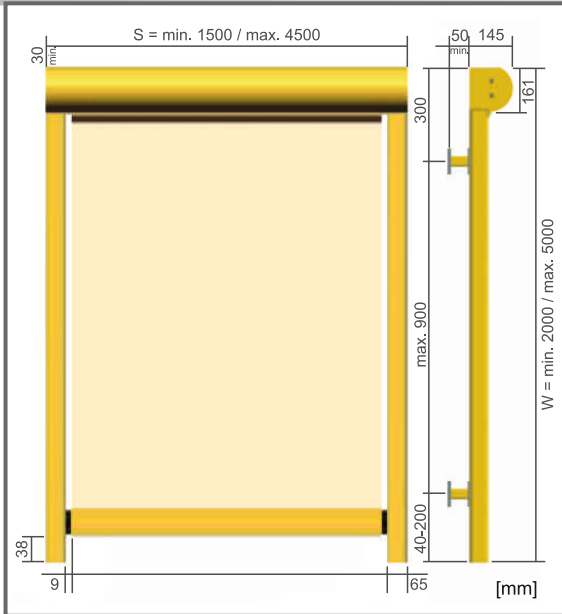

Max. shading surface 18m²

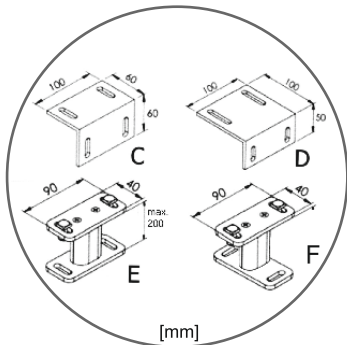

Brackets - standard „E“



Standard construction colours:



Real colours can be slightly different than colours above.

In standard:

- Min. width 150 cm
- Max. surface. 18 m²
- Brackets

ZIP

Fabric in guides

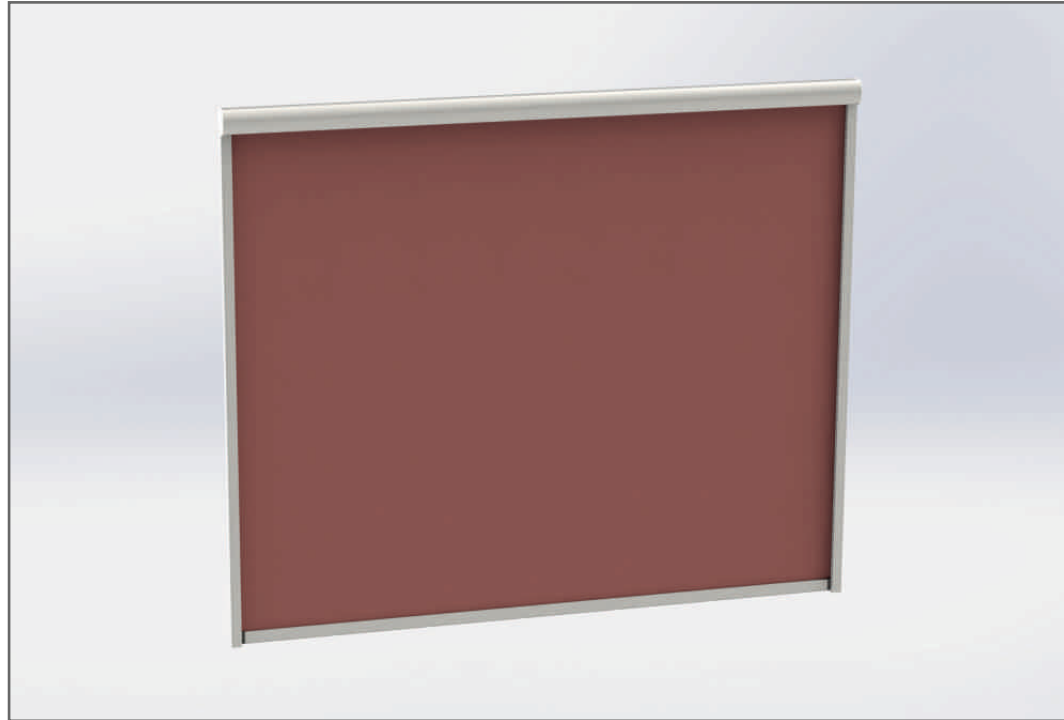
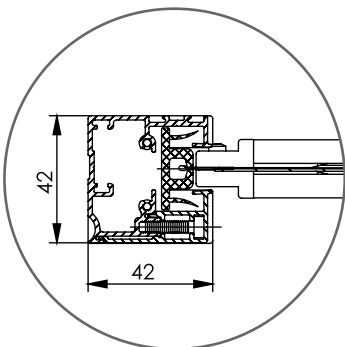
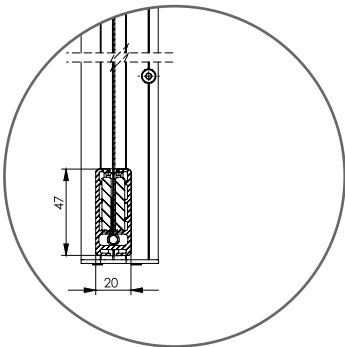
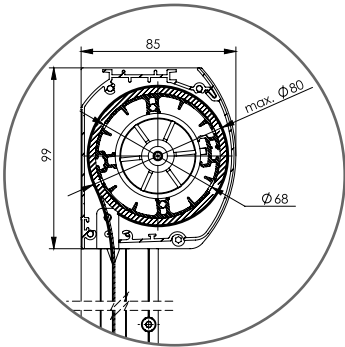
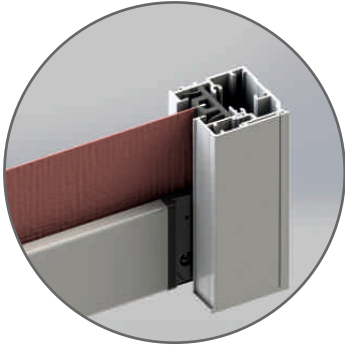

fabric possible only in this area

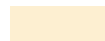

Standard construction colours:



RAL
9016

Traffic
white



RAL
9006

White
aluminum



anthracite

Anthracite



any RAL

+25%

In standard:

- Cassette
- Wall & ceiling brackets
- Fabric EKRAN
- Required control is surcharged

Real colours can be slightly different than colours above.

DUO

For backyard gardens, restaurant gardens, fairs and picnics

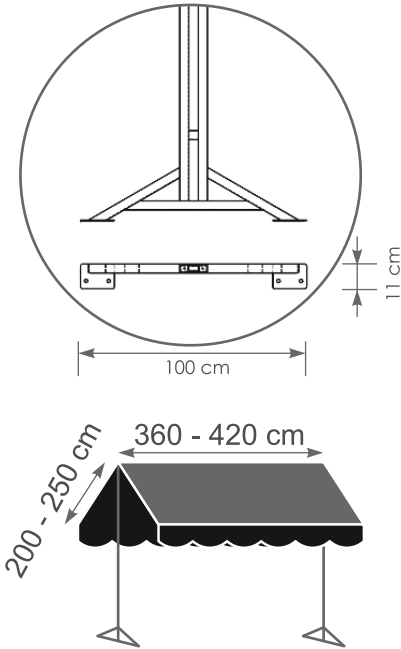

Standard construction colour:

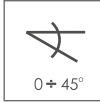

Oyster white

Real colours can be slightly different than colours above.



Tolerance in overall width is ± 2 cm

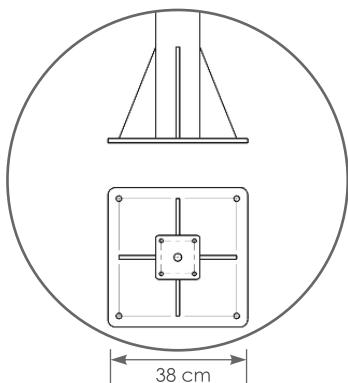
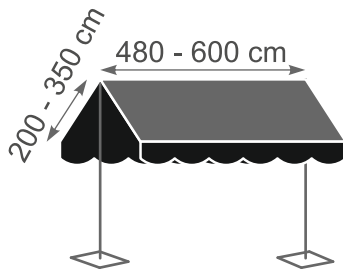

BELL & CLEO

Side leg

Central leg

BELL



diameter 420 cm, 8 pieces, height 300 cm



Closed parasol

- Opening by crank
- Telescopic construction
- Rounded base, weight 168 kg
- Cover - 100 Euro

FABRICS



Lime raindrops

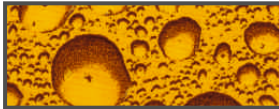

Gold raindrops

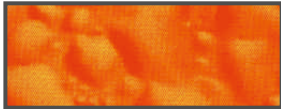

Orange raindrops

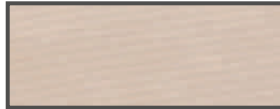

Natural



Dark green

CLEO



diameter 400 cm, 8 pieces, height 300 cm



Closed parasol

- Opening by easyshift - handle
- Telescopic construction
- Square base, weight 118 kg
- Cover - 100 Euro

Services

and spare parts

Awning type	Wall bracket [pc.]		Ceiling bracket [pc.]		Rafter bracket [pc.]		Side bracket COMO, CAPRI [pc.]	
Code	MW-W02..... (colour)	17,00	ME-S01..... (colour)	21,00	MR-S03..... (colour)	31,00	MN-W08..... (colour)	8,00
PIANO MEZZO FORTE CROSS ADAGIO ALLEGRO								

colours description: b - traffic white RAL-9016; k - oyster white RAL-1013; s - white aluminum RAL-9006;
r - chocolate brown RAL-8017; t - anthracite

Code Projection Price	Arms [pc.] MEZZO, ADAGIO, PRESTO	Code Projection Price	Arms [pc.] VIVO, PIANO, PRESTO	Arm support [pc.] MEZZO, ADGIO, PIANO	
ME-M25L..... ME-M25P..... 2,5 m - 105 Euro		ME-P15L..... ME-P15P..... 1,5 m - 86 Euro		MM-WREL..... MM-WREP.....	57 Euro
ME-M30L..... ME-M30P..... 3,0 m - 115 Euro		ME-P20L..... ME-P20L..... 2,0 m - 95 Euro			
ME-M35L..... ME-M35P..... 3,5 m - 140 Euro		ME-P25L..... ME-P25P..... 2,5 m - 100 Euro			
ME-MF40L..... ME-MF40P..... 4,0 m - 300 Euro		ME-M30L..... ME-M30P..... 3,0 m - 125 Euro		FORTE	
				ME-F01L..... ME-F01P.....	143 Euro

Service description	Price for fabric collection [Euro/m ²]*		
	brown	silver	gold
Fabric sewing (without exchange)	35	35	41

* Price is charged for each m²

NET SURCHARGES:

Repainting of } SYMFONIA. 15 % of value (14 days)
awning construction } Others 25 % of value (14 days)
Awning visualization 35 Euro (without discount)
Overprint on fabric or valance quotation

Standard crank lengths [cm]:

100, 150, 180, 200, 250 - included in awning price

FIXING

Products

Type	Description	Code	Price		Required for one bracket	Application
			EUR	Unit		
 Threaded rod - stainless steel	∅ 12 x 150 mm	MM-12x16	2,50	set	2	Installation without insulation
	∅ 12 x 300 mm	MM-12x30	3,00	set	2	Insulation max 15 cm
 Steel injection anchor sleeve	∅ 16 x 1000 mm	MM-SS1-s	18,00	pc.	25 cm	Perforated brick masonry
 PVC injection anchor sleeve	∅ 16 x 130 mm	MM-SP1-s	1,00	pc.	2	Perforated brick masonry
 Glue	KOELNER 300 ml	MM-K30-s	18,00	pc.	ok. 50 ml	All types of base
	KOELNER 175 ml	MM-K17-s	12,00	pc.		
 Aluminum spacer cube 120 x 55 x 110 mm	9016	MU-A02-b	16,00	pc.	1	Insulation 5 - 10 cm
	1013	MU-A02-k			2	Insulation 11 - 20 cm
 Spacer tubes + washers	∅ 50 x 110 mm	MU-T11-a	9,00	pair	1	Insulation 5 - 11 cm
	∅ 50 x 160 mm	MU-T16-a	13,00		1	Insulation 12 - 16 cm
	∅ 50 x 210 mm	MU-T21-a	16,00		1	Insulation 17 - 21 cm
	1 lb + 9 washers	∅ 50 x 1000 mm	MU-T00-a	36,00	set	-

Tools

Type	Description	Code	Price		Application
			EUR	Unit	
 Application gun	Dispenser	MM-N01-s	48,00	pc.	For glue application
 Hole saw	∅ 50 mm	MM-N02-s	119,00	pc.	Cutting a hole for PVC spacer tubes
 Blow-out pump ABG		MM-N03-s	38,00	pc.	For blowing into holes to remove excess dust

RADIANT HEATER

PRO-01



Standard construction colour:

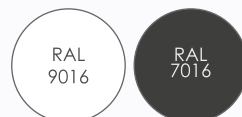

Traffic white Dark grey

Real colours can be slightly different than colours above.

Description:

- Power 2 kW
- Dimensions 54x10 cm
- Security class IP65
- Heating surface 12m²
- Control remote control
(4 heating phases) 25%, 50%, 75%, 100%



Remote control

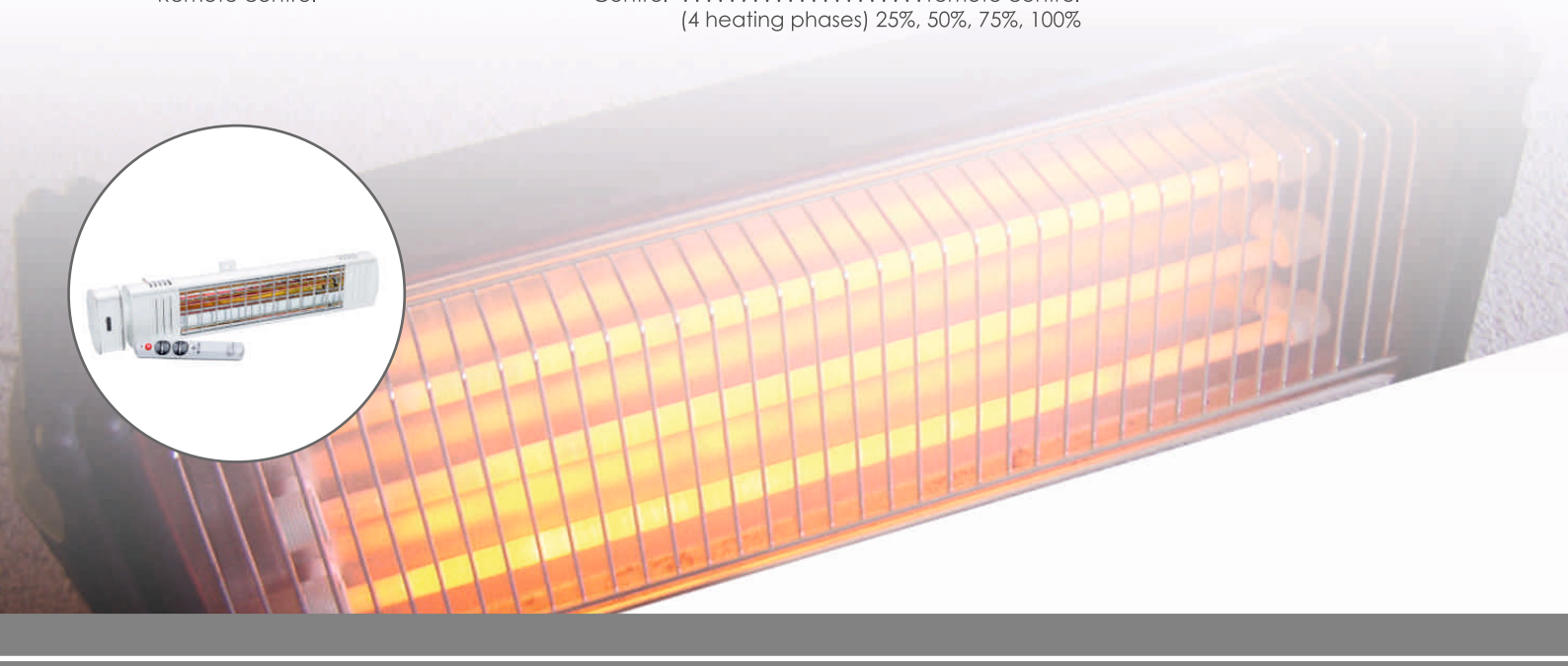
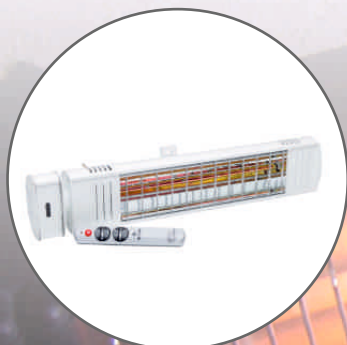

SPECIFICATION OF ACRYLIC FABRICS

Specification			Characteristics			
Our reference	Origin		Weight [g/m ²]	UV resistance	Tensile strength [N/5cm]	
	Country	Supplier	UNE-EN ISO 2286-2	UNE-EN ISO 105 B04	Along the warp	Along the thread
CIT...	Spain	Citel	295	7 - 8/ 8°	1300	750
REC...	Spain	Recasens	290	7 - 8/ 8°	1300	780
T...	Italy	Para	300	7 - 8/ 8°	1600	860
SUN.../DIC.../ORC...	France	Dickson	290	4 - 5/ 5°	1400	900

UV resistance:

Fabrics	Energetic: % of heat			Optical: % of visible light
	Ts Solar (transmission)	Rs Solar (reflection)	As Solar (absorption)	Tv Solar (transmission)
Dark	0,33 - 16,19	6,95 - 48,48	35,33 - 92,72	0,33 - 7,08
Light	11,7 - 26,98	40,87 - 64,82	8,20 - 47,43	5,16 - 27,09

Nature of awning fabrics:

Despite the highest quality, there may be some imperfections on the fabric caused by the nature and properties of acrylic or polyester yarn and the necessity of sewing it or wrapping the edges.

1) Ripples: due to small movements during sewing, all fabrics impregnated with fluoride resins may have little ripples visible on the light, resulting refraction of sunlight.

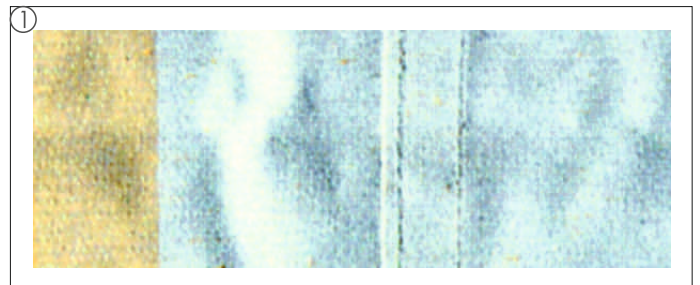

2) Ruffles: in the consequence of joining a fabric and wrapping the edges (double fabric thickness), ruffles similar to herringbone may occur.

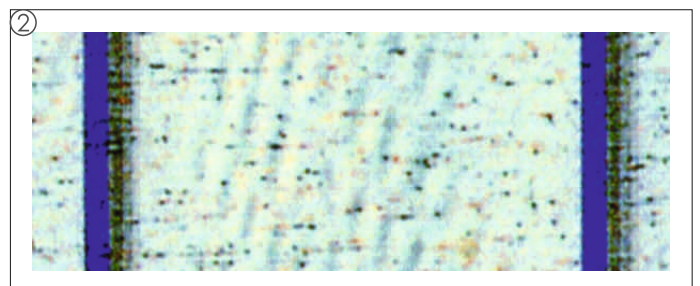

3) Lines „Veins“: using resins that contain fluorides causes visible lines on the fabric in the place of crease - mainly noticeable on polyester fabrics.



PLEASE NOTE! All above imperfections are a consequence of natural characteristics of the fabric and it has to be familiar to the final users. It cannot be a cause of claim.

FABRICS



ORC-6273

pg. 1



SWE-827

pg. 2



CIT-165

pg. 3



REC-139

pg. 95



T-967/926

pg. 4



SUN-5382

pg. 5



REC-181

pg. 96



REC-195

pg. 96



CIT-551

pg. 6



REC-143

pg. 96



CIT-228

pg. 7



CIT-504

pg. 8



T-407/7

pg. 96



T-1300

pg. 96



REC-126

pg. 95

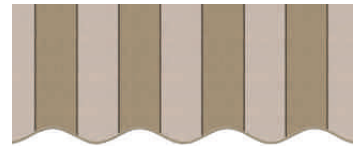

T-5371/106

pg. 9



REC-085

pg. 10



REC-775

pg. 95



SAT-716

pg. 11



T-986/106

pg. 95



ORC-D326

pg. 12



REC-097

pg. 13



SUN-F038

pg. 14

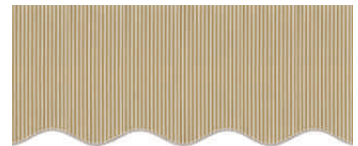

REC-812

pg. 15



T-5355/106

pg. 16



SWE-447

pg. 17

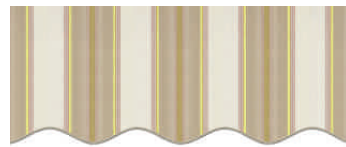

SWE-687

pg. 18



REC-283

pg. 19



REC-117

pg. 94

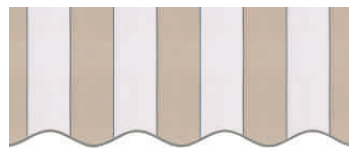

CIT-502

pg. 20



SUN-F051

pg. 21



ORC-D100

pg. 22



ORC-8935

pg. 23



REC-779

pg. 95

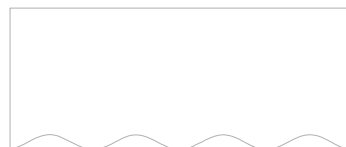

pg. ...

bronze collection, page in awning catalog

pg

silver collection page in awning catalog



FABRICS



SUN-F048 pg. 24



SUN-5387 pg. 25



SUN-F047 pg. 26



ORC-D324 pg. 27



REC-148 pg. 94



SUN-5121 pg. 28

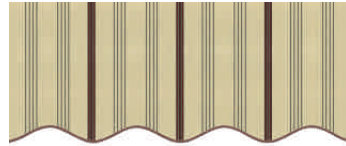

SAT-720 pg. 29



ORC-7548 pg. 94



SUN-5388 pg. 30



CIT-458 pg. 31



T-5348/14 pg. 32



SWE-454 pg. 33

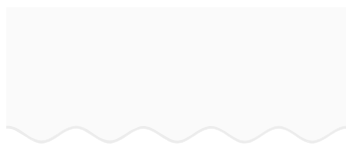

T-15 pg. 94



SWE-442 pg. 34



REC-272 pg. 35

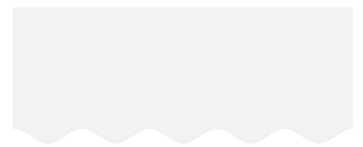

REC-415 pg. 94



REC-114 pg. 93



T-986/15 pg. 93



T-986/727 pg. 93



REC-138 pg. 93



REC-152 pg. 93



T-727/15 pg. 92



T-107 pg. 92



REC-164 pg. 92



REC-770 pg. 92



REC-103 pg. 92



REC-094 pg. 36



REC-060 pg. 37



REC-089 pg. 38

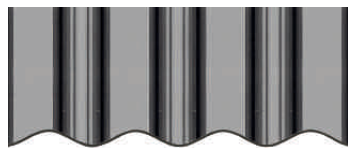

T-950/24 pg. 39



REC-051 pg. 40



SUN-5372 pg. 41



SUN-5397 pg. 42



SUN-5128 pg. 43

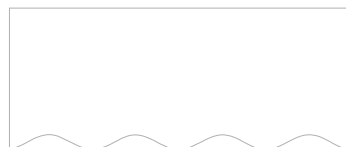

pg. ...
pg. ...

bronze collection, page in awning catalog
silver collection, page in awning catalog

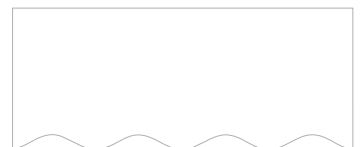

FABRICS



ORC-D319 pg. 44



SUN-F037 pg. 45

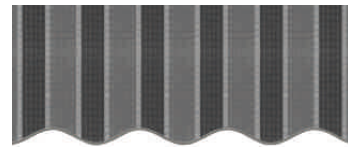

ORC-D108 pg. 46



ORC-D325 pg. 47



ORC-D113 pg. 48



SUN-5386 pg. 49

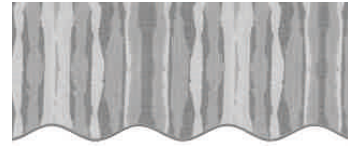

SUN-F049 pg. 50



CIT-361 pg. 51

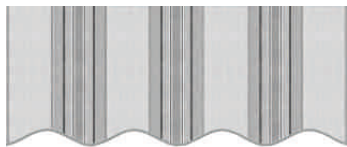

T-5348/79 pg. 52

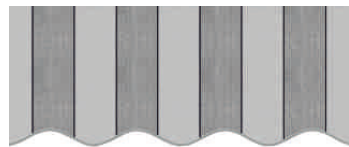

T-5371/727 pg. 53



ORC-D320 pg. 54



ORC-D328 pg. 55



ORC-8931 pg. 56



SUN-5116 pg. 57



SAT-637 pg. 58



SWE-826 pg. 59



SWE-815 pg. 60



CIT-171 pg. 61



T-14/16 pg. 99



T-16 pg. 99



REC-142 pg. 99



REC-102 pg. 99



REC-098 pg. 62



CIT-230 pg. 63



REC-720 pg. 64



T-944/12 pg. 65



REC-554 pg. 97



REC-101 pg. 97



REC-567 pg. 97



T-26/15 pg. 97



REC-149 pg. 99



REC-158 pg. 97



T-944/926 pg. 66



T-939/58 pg. 67

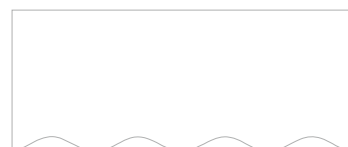

pg. ... bronze collection, page in awning catalog

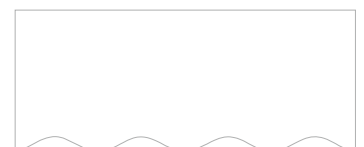

pg. ... silver collection, page in awning catalog

FABRICS



T-939/12 pg. 68



REC-095 pg. 69



SWE-851 pg. 70



SWE-811 pg. 71



ORC-D323 pg. 72



REC-231 pg. 73

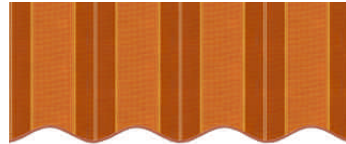

SWE-852 pg. 74

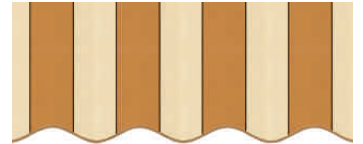

REC-798 pg. 75



T-56 pg. 98

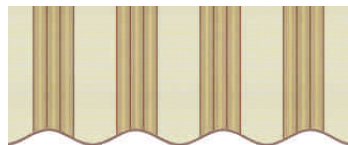

CIT-433 pg. 76



SWE-683 pg. 77



T-959/84 pg. 78



T-966/426 pg. 79



REC-104 pg. 98



SWE-812 pg. 80



SWE-424 pg. 81



CIT-448 pg. 82



CIT-643 pg. 83



CIT-170 pg. 84



REC-182 pg. 98



REC-096 pg. 85



SWE-829 pg. 86



T-407/11 pg. 98



REC-070 pg. 87



REC-177 pg. 98

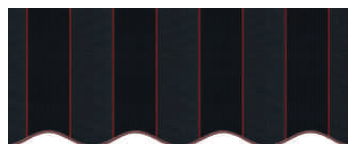

SWE-818 pg. 88



SWE-813 pg. 89



REC-093 pg. 90



REC-425 pg. 91



REC-110 pg. 100



REC-169 pg. 100



REC-172 pg. 100



REC-173 pg. 100



REC-170 pg. 100

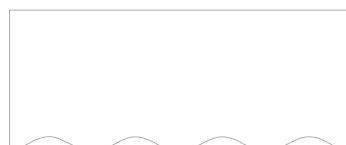

pg. ...
pg. ...

bronze collection, page in awning catalog
silver collection, page in awning catalog

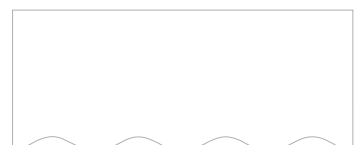

WATERPROOF FABRICS

Recsystem - Water Proof



RWD-099



RWD-117

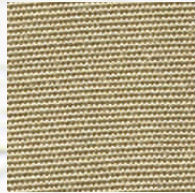

RWD-100



RWD-139

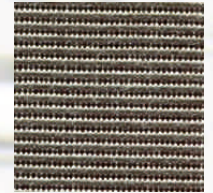

RWD-775



RWD-554



RWD-567

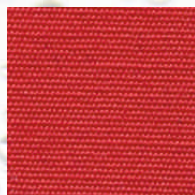

RWD-176

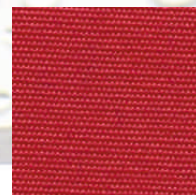

RWD-182

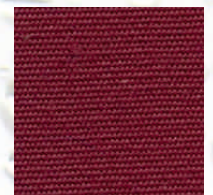

RWD-177

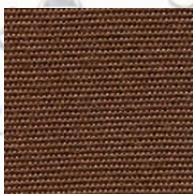

RWD-195

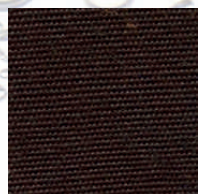

RWD-156

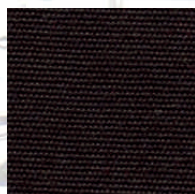

RWD-181

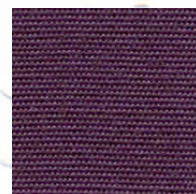

RWD-165



RWD-172



RWD-173



RWD-170

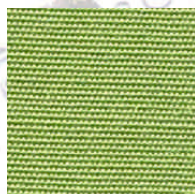

RWD-160

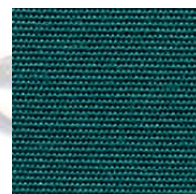

RWD-163

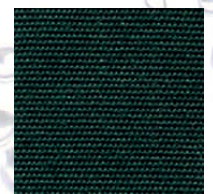

RWD-102



RWD-138



RWD-161



RWD-164

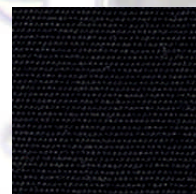

RWD-103

Specification			
Properties	Values	Properties	Values
Waterproof	>100 cm water column (ISO 811/81)	Composition	100% acrylic dyed in a mass
Impregnation	Acrylic, crease and stain resistant	Weight	325 g/m ² ±5 %
Tensile strength [N/5cm]	Along the warp: 1550 ±5 %	The width of the roller	120 cm ±1%
	Along the thread: 900 ±5 %	The length of the roller	60 m

When you use waterproof fabric, recommended angle of inclination is 30°

FABRICS

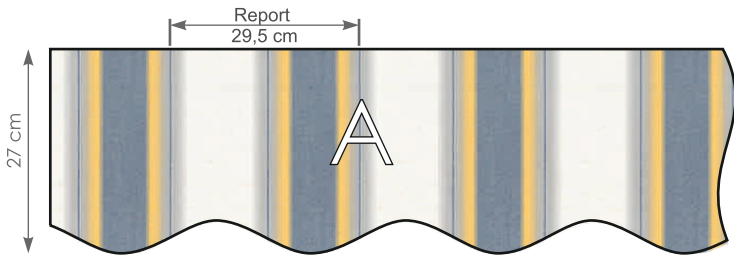

Recommended for cassettes and semi-cassettes

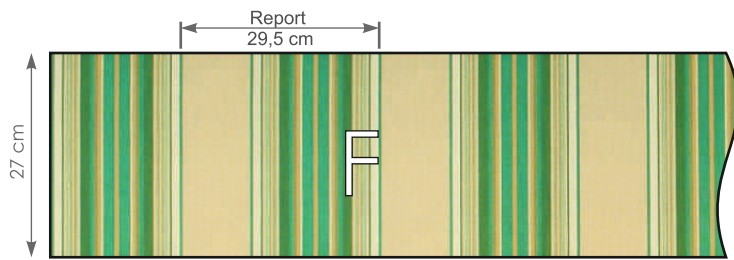
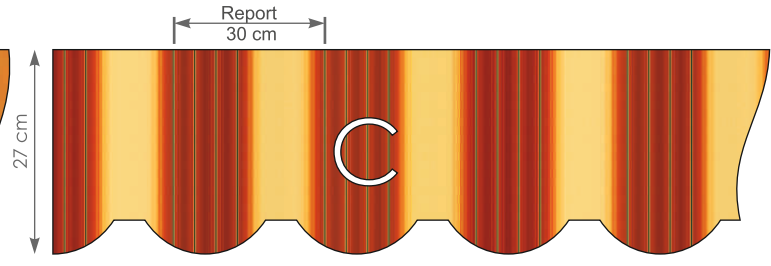
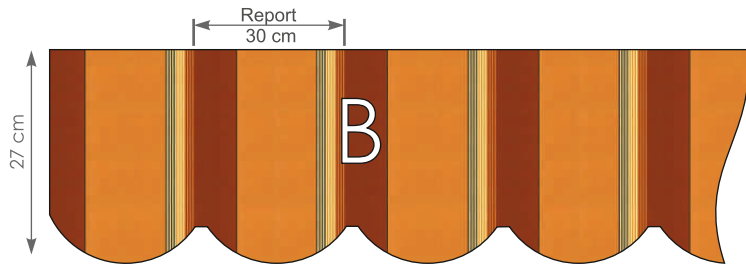

Recommended for cassettes and semi-cassettes



Cent pour Cent Materiaux

centre commercial cap caer

27930 Normanville

contact : cantel johan 06 52 91 65 75

mail : romain@centpourcent-materiaux.com